

## CRASH SUSPENSION

### D131065- \_\_\_\_\_

base number

1. To build a product code in our configurator select the specify button on the base model # product page
2. To build a manual product code on this datasheet choose from the options listed below in blue font and add the suffix to the base model #

#### GENERAL

Series: Crash  
Brand: Knikerboker  
Division: Design  
Mounting Type: Suspension  
Mounting Location: Ceiling  
Subcategory: Pendant

#### PHYSICAL

Shape: Abstract  
Length (mm): 1000  
Length (in): 39 <sup>3</sup>/<sub>8</sub>  
Width (mm): 1000  
Width (in): 39 <sup>3</sup>/<sub>8</sub>  
Max. Overall Height (mm): 2000  
Max. Overall Height (in): 78 <sup>3</sup>/<sub>4</sub>  
Light Distribution: Indirect  
Fixture Finish: EWH / EBK / MAN / COF / PRD / SLF / GLF / CLF / BRL / EWS / EWG / EWC / EWR / EBS / EBG / EBC / EBC / EBB / MAS / MAD / MAC / MAB / COS / CGO / CCL / CBL / PRS / PRG / PRC / PRB  
Fixture Material: Metal  
Cable Details: 4 Steel Cable 2000mm / 78 3/4" - Silicon Cable 2000mm / 78 3/4"

#### ELECTRICAL

Lamp Type: LED Retrofit  
Input Wattage (W): 21  
Total Output Wattage (W): 20  
Dimming: Tri-Mode (Non-Dimming and Phase Dimming (120Vac only) and 0-10V Dimming)  
Driver Included: Yes  
Driver Location: Integrated  
Driver Type: Constant Current - Universal  
Driver Class: Class 2  
Input Voltage (V): 120 - 277  
Constant Current (MA): 250  
Upon Request: 0-10Vdc dimming / Phase dimming @120Vac / 277Vac

#### LED

Number of LEDs: 2  
Color Temperature (°K): 3000  
Max. Delivered Lumen (lm): 2200  
CRI: >85 CRI  
Lamp Life (hrs): 50000

#### OPTICAL

#### RATINGS AND CERTIFICATIONS

Certified By: Certified for North American Standards  
IP rating: IP20

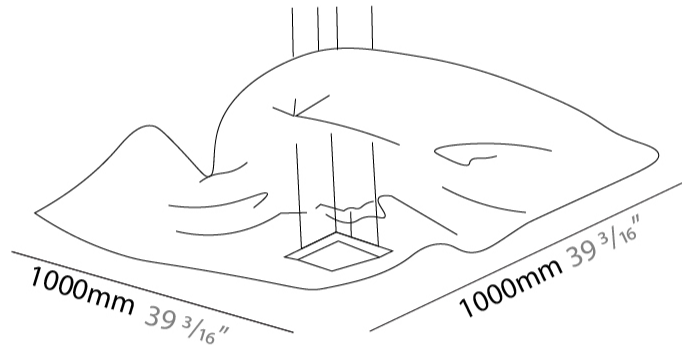

## CRASH SUSPENSION

D131065-

PROJECT \_\_\_\_\_

TYPE \_\_\_\_\_

SPECIFIER \_\_\_\_\_

QUANTITY \_\_\_\_\_

DATE \_\_\_\_\_



D

## CRASH SUSPENSION

**D131068-** \_\_\_\_\_  
base number

PROJECT
TYPE
SPECIFIER
QUANTITY
DATE

- To build a product code in our configurator select the specify button on the base model # product page
- To build a manual product code on this datasheet choose from the options listed below in blue font and add the suffix to the base model #

### GENERAL

Series: Crash  
 Brand: Knikerboker  
 Division: Design  
 Mounting Type: Suspension  
 Mounting Location: Ceiling  
 Subcategory: Pendant

### PHYSICAL

Shape: Curves  
 Length (mm): 1500  
 Length (in): 59 1/16  
 Width (mm): 1500  
 Width (in): 59 1/16  
 Max. Overall Height (mm): 2000  
 Max. Overall Height (in): 78 3/4  
 Light Distribution: Indirect  
 Fixture Finish: EWH / EBK / MAN / COF / PRD / SLF / GLF / CLF / BRL / EWS / EWG / EWC / EWR / EBS / EBG / EBC / EBC / EBB / MAS / MAD / MAC / MAB / COS / CGO / CCL / CBL / PRS / PRG / PRC / PRB  
 Fixture Material: Metal  
 Cable Details: 4 Steel Cable 2000mm / 78 3/4" - Silicon Cable 2000mm / 78 3/4"

### ELECTRICAL

Lamp Type: LED  
 Input Wattage (W): 31.5  
 Total Output Wattage (W): 30  
 Dimming: Tri-Mode (Non-Dimming and Phase Dimming (120Vac only) and 0-10V Dimming)  
 Driver Included: Yes  
 Driver Location: Integrated  
 Driver Type: Constant Current - Universal  
 Driver Class: Class 2  
 Input Voltage (V): 120 - 277  
 Constant Current (MA): 250  
 Upon Request: 0-10Vdc dimming / Phase dimming @120Vac / 277Vac

### LED

Number of LEDs: 3  
 Color Temperature (°K): 3000  
 Max. Delivered Lumen (lm): 3300  
 CRI: >85 CRI  
 Lamp Life (hrs): 50000

### OPTICAL

### RATINGS AND CERTIFICATIONS

Certified By: Certified for North American Standards  
 IP rating: IP20



## CRASH SUSPENSION

D131068-

PROJECT \_\_\_\_\_

TYPE \_\_\_\_\_

SPECIFIER \_\_\_\_\_

QUANTITY \_\_\_\_\_

DATE \_\_\_\_\_



D

PROJECT	_____
TYPE	_____
SPECIFIER	_____
QUANTITY	_____
DATE	_____

## CRASH SUSPENSION

**D131071-** \_\_\_\_\_  
base number

- To build a product code in our configurator select the specify button on the base model # product page
- To build a manual product code on this datasheet choose from the options listed below in blue font and add the suffix to the base model #

### GENERAL

Series: Crash  
 Brand: Knikerboker  
 Division: Design  
 Mounting Type: Suspension  
 Mounting Location: Ceiling  
 Subcategory: Pendant

### PHYSICAL

Shape: Curves  
 Length (mm): 2500  
 Length (in): 98 7/16  
 Width (mm): 620  
 Width (in): 24 7/16  
 Max. Overall Height (mm): 2000  
 Max. Overall Height (in): 78 3/4  
 Light Distribution: Indirect  
 Fixture Finish: EWH / EBK / MAN / COF / PRD / SLF / GLF / CLF / BRL / EWS / EWG / EWC / EWR / EBS / EBG / EBC / EBC / EBB / MAS / MAD / MAC / MAB / COS / CGO / CCL / CBL / PRS / PRG / PRC / PRB  
 Fixture Material: Metal  
 Cable Details: 4 Steel Cable 2000mm / 78 3/4" - Silicon Cable 2000mm / 78 3/4"

### ELECTRICAL

Lamp Type: LED  
 Input Wattage (W): 42  
 Total Output Wattage (W): 40  
 Dimming: Tri-Mode (Non-Dimming and Phase Dimming (120Vac only) and 0-10V Dimming)  
 Driver Included: Yes  
 Driver Location: Integrated  
 Driver Type: Constant Current - Universal  
 Driver Class: Class 2  
 Input Voltage (V): 120 - 277  
 Constant Current (MA): 250  
 Upon Request: 0-10Vdc dimming / Phase dimming @120Vac / 277Vac

### LED

Number of LEDs: 4  
 Color Temperature (°K): 3000  
 Max. Delivered Lumen (lm): 4400  
 CRI: >85 CRI  
 Lamp Life (hrs): 50000

### OPTICAL

### RATINGS AND CERTIFICATIONS

Certified By: Certified for North American Standards  
 IP rating: IP20



## CRASH SUSPENSION

D131071-

PROJECT \_\_\_\_\_

TYPE \_\_\_\_\_

SPECIFIER \_\_\_\_\_

QUANTITY \_\_\_\_\_

DATE \_\_\_\_\_



D

PROJECT
TYPE
SPECIFIER
QUANTITY
DATE

## CRASH SUSPENSION

**D131425-** \_\_\_\_\_  
base number

- To build a product code in our configurator select the specify button on the base model # product page
- To build a manual product code on this datasheet choose from the options listed below in blue font and add the suffix to the base model #

### GENERAL

Series: Crash  
 Brand: Knikerboker  
 Division: Design  
 Mounting Type: Suspension  
 Mounting Location: Ceiling  
 Subcategory: Pendant

### PHYSICAL

Shape: Abstract  
 Length (mm): 500  
 Length (in): 19 <sup>11</sup>/<sub>16</sub>  
 Width (mm): 500  
 Width (in): 19 <sup>11</sup>/<sub>16</sub>  
 Extension (mm): 2000  
 Extension (in): 78 <sup>3</sup>/<sub>4</sub>  
 Light Distribution: Indirect  
 Fixture Finish: EWH / EBK / MAN / COF / PRD / SLF / GLF / CLF / BRL / EWS / EWG / EWC / EWR / EBS / EBG / EBC / EBC / EBB / MAS / MAD / MAC / MAB / COS / CGO / CCL / CBL / PRS / PRG / PRC / PRB  
 Fixture Material: Metal  
 Cable Detail: 4 Steel Cable 2000mm / 78 3/4" - Silicon Cable 2000mm / 78 3/4"

### ELECTRICAL

Lamp Type: LED  
 Input Wattage (W): 10.5  
 Total Output Wattage (W): 10  
 Dimming: Tri-Mode (Non-Dimming and Phase Dimming (120Vac only) and 0-10V Dimming)  
 Driver Included: Yes  
 Driver Location: Integrated  
 Driver Type: Constant Current - Universal  
 Driver Class: Class 2  
 Input Voltage (V): 120 - 277  
 Constant Current (MA): 250  
 Upon Request: 0-10Vdc dimming / Phase dimming @120Vac / 277Vac

### LED

Color Temperature (°K): 3000  
 Max. Delivered Lumen (lm): 1100  
 CRI: >85 CRI  
 Lamp Life (hrs): 50000

### OPTICAL

### RATINGS AND CERTIFICATIONS

Certified By: Certified for North American Standards  
 IP rating: IP20

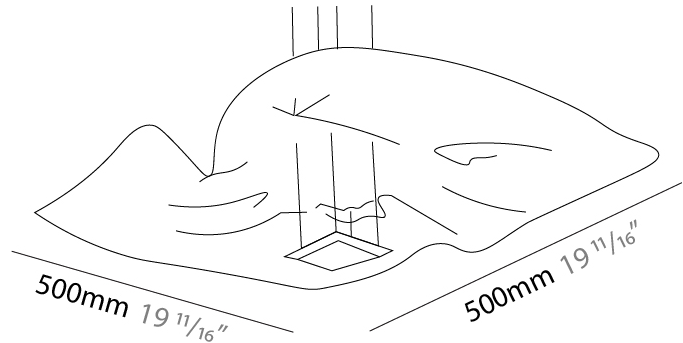

## CRASH SUSPENSION

D131425-

PROJECT \_\_\_\_\_

TYPE \_\_\_\_\_

SPECIFIER \_\_\_\_\_

QUANTITY \_\_\_\_\_

DATE \_\_\_\_\_

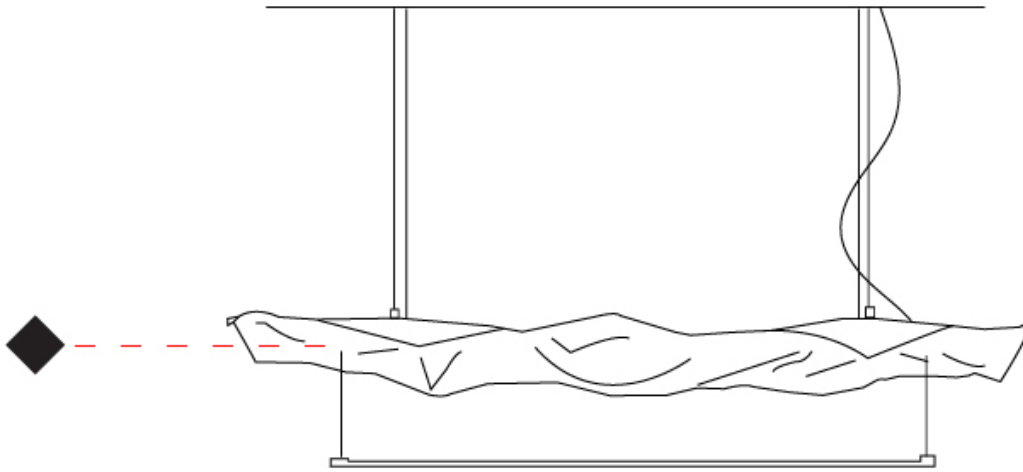

D



## CRASH SUSPENSION

**D131439-** \_\_\_\_\_  
 base number

- To build a product code in our configurator select the specify button on the base model # product page
- To build a manual product code on this datasheet choose from the options listed below in blue font and add the suffix to the base model #

### GENERAL

Series: Crash  
 Brand: Knikerboker  
 Division: Design  
 Mounting Type: Suspension  
 Mounting Location: Ceiling  
 Subcategory: Pendant

### PHYSICAL

Shape: Abstract  
 Length (mm): 1000  
 Length (in): 39 <sup>3</sup>/<sub>8</sub>  
 Width (mm): 750  
 Width (in): 29 <sup>1</sup>/<sub>2</sub>  
 Max. Overall Height (mm): 2000  
 Max. Overall Height (in): 78 <sup>3</sup>/<sub>4</sub>  
 Light Distribution: Indirect  
 Fixture Finish: EWH / EBK / MAN / COF / PRD / SLF / GLF / CLF / BRL / EWS / EWG / EWC / EWR / EBS / EBG / EBC / EBC / EBB / MAS / MAD / MAC / MAB / COS / CGO / CCL / CBL / PRS / PRG / PRC / PRB  
 Fixture Material: Metal  
 Cable Details: 4 Steel Cable 2000mm / 78 3/4" - Silicon Cable 2000mm / 78 3/4"

### ELECTRICAL

Lamp Type: LED  
 Input Wattage (W): 10.5  
 Total Output Wattage (W): 10  
 Dimming: Tri-Mode (Non-Dimming and Phase Dimming (120Vac only) and 0-10V Dimming)  
 Driver Included: Yes  
 Driver Location: Integrated  
 Driver Type: Constant Current - Universal  
 Driver Class: Class 2  
 Input Voltage (V): 120 - 277  
 Constant Current (MA): 250  
 Upon Request: 0-10Vdc dimming / Phase dimming @120Vac / 277Vac

### LED

Number of LEDs: 1  
 Color Temperature (°K): 3000  
 Max. Delivered Lumen (lm): 2200  
 CRI: >85 CRI  
 Lamp Life (hrs): 50000

### OPTICAL

### RATINGS AND CERTIFICATIONS

Certified By: Certified for North American Standards  
 IP rating: IP20

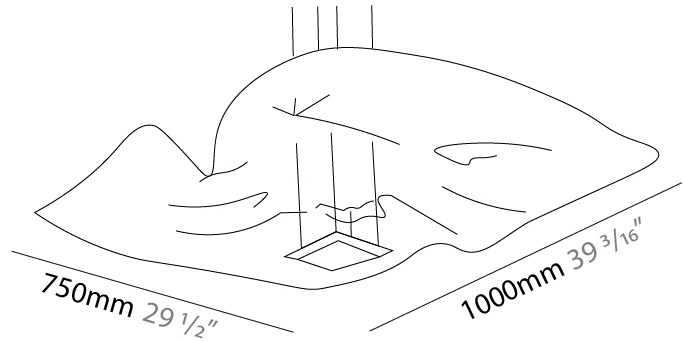

## CRASH SUSPENSION

D131439-

PROJECT \_\_\_\_\_

TYPE \_\_\_\_\_

SPECIFIER \_\_\_\_\_

QUANTITY \_\_\_\_\_

DATE \_\_\_\_\_



D

## CRASH SURFACE

**D132044-** \_\_\_\_\_  
base number

PROJECT
TYPE
SPECIFIER
QUANTITY
DATE

- To build a product code in our configurator select the specify button on the base model # product page
- To build a manual product code on this datasheet choose from the options listed below in blue font and add the suffix to the base model #

### GENERAL

Series: Crash  
 Brand: Knikerboker  
 Division: Design  
 Mounting Type: Surface  
 Mounting Location: Ceiling  
 Subcategory: Ambient

### PHYSICAL

Shape: Abstract  
 Length (mm): 1000  
 Length (in): 39 3/8  
 Width (mm): 400  
 Width (in): 15 3/4  
 Height (mm): 240  
 Height (in): 9 7/16  
 Extension (mm): 250  
 Extension (in): 9 13/16  
 Light Distribution: Indirect  
 Fixture Finish: EWH / EBK / MAN / COF / PRD / SLF / GLF / CLF / BRL / EWS / EWG / EWC / EWR / EBS / EBG / EBC / EBC / EBB / MAS / MAD / MAC / MAB / COS / CGO / CCL / CBL / PRS / PRG / PRC / PRB  
 Fixture Material: Metal

### ELECTRICAL

Lamp Type: LED  
 Input Wattage (W): 10.5  
 Total Output Wattage (W): 10  
 Dimming: Tri-Mode (Non-Dimming and Phase Dimming (120Vac only) and 0-10V Dimming)  
 Driver Included: Yes  
 Driver Location: Integrated  
 Driver Type: Constant Current - Universal  
 Driver Class: Class 2  
 Input Voltage (V): 120 - 277  
 Constant Current (MA): 250  
 Upon Request: 0-10Vdc dimming / Phase dimming @120Vac / 277Vac

### LED

Number of LEDs: 1  
 Color Temperature (°K): 3000  
 Max. Delivered Lumen (lm): 2200  
 CRI: >85 CRI  
 Lamp Life (hrs): 50000

### OPTICAL

### RATINGS AND CERTIFICATIONS

Certified By: Certified for North American Standards  
 IP rating: IP20

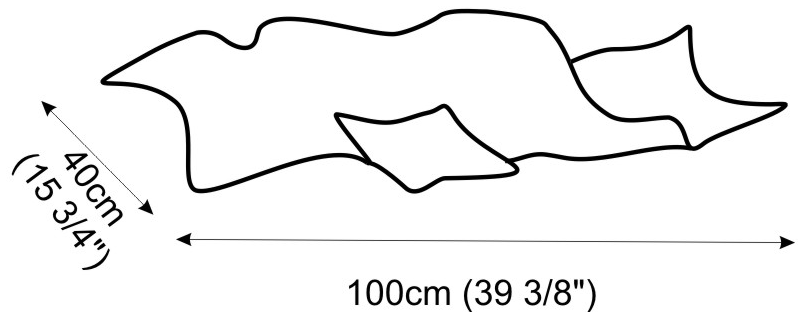

PROJECT	_____
TYPE	_____
SPECIFIER	_____
QUANTITY	_____
DATE	_____

## CRASH SURFACE

**D132047-** \_\_\_\_\_  
base number

- To build a product code in our configurator select the specify button on the base model # product page
- To build a manual product code on this datasheet choose from the options listed below in blue font and add the suffix to the base model #

### GENERAL

Series: Crash  
 Brand: Knikerboker  
 Division: Design  
 Mounting Type: Surface  
 Mounting Location: Ceiling

### PHYSICAL

Shape: Rectangle  
 Length (mm): 300  
 Length (in): 11 <sup>13</sup>/<sub>16</sub>  
 Width (mm): 300  
 Width (in): 11 <sup>13</sup>/<sub>16</sub>  
 Light Distribution: Indirect  
 Fixture Finish: EWH / EBK / MAN / COF / PRD / SLF / GLF / CLF / BRL / EWS / EWG / EWC / EWR / EBS / EBG / EBC / EBC / EBB / MAS / MAD / MAC / MAB / COS / CGO / CCL / CBL / PRS / PRG / PRC / PRB  
 Fixture Material: Metal

### ELECTRICAL

Lamp Type: LED  
 Input Wattage (W): 10.5  
 Total Output Wattage (W): 10  
 Dimming: Tri-Mode (Non-Dimming and Phase Dimming (120Vac only) and 0-10V Dimming)  
 Driver Included: Yes  
 Driver Location: Integrated  
 Driver Type: Constant Current - Universal  
 Driver Class: Class 2  
 Input Voltage (V): 120 - 277  
 Constant Current (MA): 250  
 Upon Request: 0-10Vdc dimming / Phase dimming @120Vac only / 277Vac

### LED

Number of LEDs: 1  
 Color Temperature (°K): 3000  
 Max. Delivered Lumen (lm): 1100  
 CRI: >85 CRI  
 Lamp Life (hrs): 50000

### OPTICAL

#### RATINGS AND CERTIFICATIONS

Certified By: Certified for North American Standards  
 IP rating: IP20

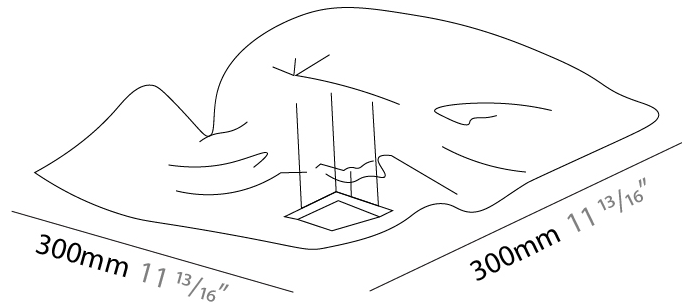

## CRASH SURFACE

D132047-

PROJECT

TYPE

SPECIFIER

QUANTITY

DATE

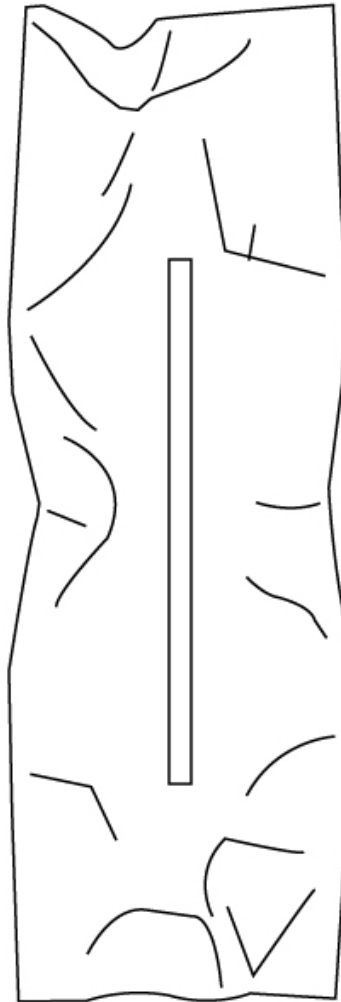

PROJECT	_____
TYPE	_____
SPECIFIER	_____
QUANTITY	_____
DATE	_____

## CRASH SURFACE

**D132050-** \_\_\_\_\_  
base number

1. To build a product code in our configurator select the specify button on the base model # product page
2. To build a manual product code on this datasheet choose from the options listed below in blue font and add the suffix to the base model #

### GENERAL

Series: Crash  
Brand: Knikerboker  
Division: Design  
Mounting Type: Surface  
Mounting Location: Ceiling

### PHYSICAL

Shape: Rectangle  
Length (mm): 500  
Length (in): 19 <sup>11</sup>/<sub>16</sub>  
Width (mm): 500  
Width (in): 19 <sup>11</sup>/<sub>16</sub>  
Height (mm): 300  
Height (in): 11 <sup>13</sup>/<sub>16</sub>  
Light Distribution: Indirect  
Fixture Finish: EWH / EBK / MAN / COF / PRD / SLF / GLF / CLF / BRL / EWS / EWG / EWC / EWR / EBS / EBG / EBC / EBC / EBB / MAS / MAD / MAC / MAB / COS / CGO / CCL / CBL / PRS / PRG / PRC / PRB  
Fixture Material: Metal

### ELECTRICAL

Lamp Type: LED  
Input Wattage (W): 21  
Total Output Wattage (W): 20  
Dimming: Tri-Mode (Non-Dimming and Phase Dimming (120Vac only) and 0-10V Dimming)  
Driver Included: Yes  
Driver Location: Integrated  
Driver Type: Constant Current - Universal  
Driver Class: Class 2  
Input Voltage (V): 120 - 277  
Constant Current (MA): 250

### LED

Number of LEDs: 2  
Color Temperature (°K): 3000  
Max. Delivered Lumen (lm): 2200  
CRI: >85 CRI  
Lamp Life (hrs): 50000

### OPTICAL

#### RATINGS AND CERTIFICATIONS

Certified By: Certified for North American Standards  
IP rating: IP20

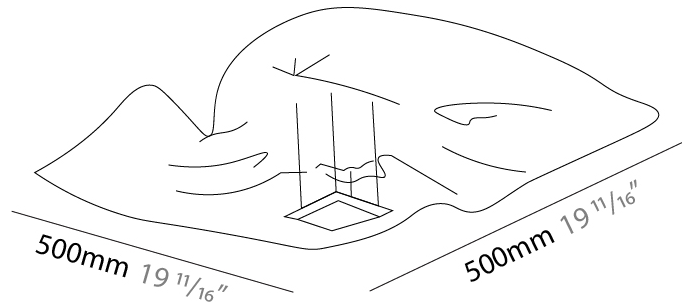

PROJECT	_____
TYPE	_____
SPECIFIER	_____
QUANTITY	_____
DATE	_____

## CRASH SURFACE

**D132053-** \_\_\_\_\_  
base number

1. To build a product code in our configurator select the specify button on the base model # product page
2. To build a manual product code on this datasheet choose from the options listed below in blue font and add the suffix to the base model #

### GENERAL

Series: Crash  
Brand: Knikerboker  
Division: Design  
Mounting Type: Surface  
Mounting Location: Ceiling

### PHYSICAL

Shape: Rectangle  
Length (mm): 750  
Length (in): 29 1/2  
Width (mm): 750  
Width (in): 29 1/2  
Extension (mm): 150  
Extension (in): 5 7/8  
Light Distribution: Indirect  
Fixture Finish: EWH / EBK / MAN / COF / PRD / SLF / GLF / CLF / BRL / EWS / EWG / EWC / EWR / EBS / EBG / EBC / EBC / EBB / MAS / MAD / MAC / MAB / COS / CGO / CCL / CBL / PRS / PRG / PRC / PRB  
Fixture Material: Metal

### ELECTRICAL

Lamp Type: LED  
Input Wattage (W): 21  
Total Output Wattage (W): 20  
Dimming: Tri-Mode (Non-Dimming and Phase Dimming (120Vac only) and 0-10V Dimming)  
Driver Included: Yes  
Driver Location: Integrated  
Driver Type: Constant Current - Universal  
Driver Class: Class 2  
Input Voltage (V): 120 - 277  
Constant Current (MA): 250  
Upon Request: 0-10Vdc dimming / Phase dimming @120Vac / 277Vac

### LED

Number of LEDs: 2  
Color Temperature (°K): 3000  
Max. Delivered Lumen (lm): 1100  
CRI: >85 CRI  
Lamp Life (hrs): 50000

### OPTICAL

#### RATINGS AND CERTIFICATIONS

Certified By: Certified for North American Standards  
IP rating: IP20

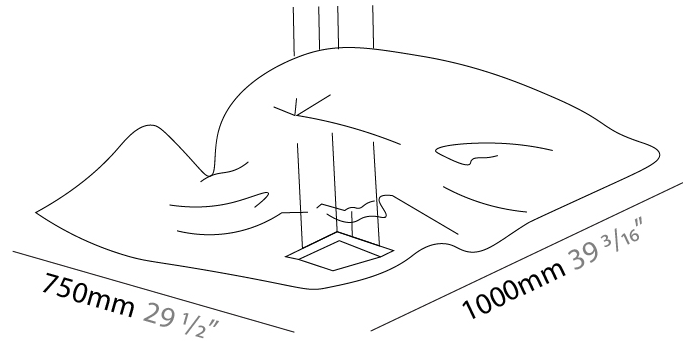

## CRASH SURFACE

D132053-

PROJECT \_\_\_\_\_

TYPE \_\_\_\_\_

SPECIFIER \_\_\_\_\_

QUANTITY \_\_\_\_\_

DATE \_\_\_\_\_



D



PROJECT	_____
TYPE	_____
SPECIFIER	_____
QUANTITY	_____
DATE	_____

## CRASH SURFACE

**D132056-** \_\_\_\_\_  
base number

- To build a product code in our configurator select the specify button on the base model # product page
- To build a manual product code on this datasheet choose from the options listed below in blue font and add the suffix to the base model #

### GENERAL

Series: Crash \_\_\_\_\_  
 Brand: Knikerboker \_\_\_\_\_  
 Division: Design \_\_\_\_\_  
 Mounting Type: Surface \_\_\_\_\_  
 Mounting Location: Ceiling \_\_\_\_\_

### PHYSICAL

Shape: Rectangle \_\_\_\_\_  
 Length (mm): 1000 \_\_\_\_\_  
 Length (in): 39 <sup>3</sup>/<sub>8</sub> \_\_\_\_\_  
 Width (mm): 1000 \_\_\_\_\_  
 Width (in): 39 <sup>3</sup>/<sub>8</sub> \_\_\_\_\_  
 Height (mm): 250 \_\_\_\_\_  
 Height (in): 9 <sup>13</sup>/<sub>16</sub> \_\_\_\_\_  
 Light Distribution: Indirect \_\_\_\_\_  
 Fixture Finish: EWH / EBK / MAN / COF / PRD / SLF / GLF / CLF / BRL / EWS / EWG / EWC / EWR / EBS / EBG / EBC / EBC / EBB / MAS / MAD / MAC / MAB / COS / CGO / CCL / CBL / PRS / PRG / PRC / PRB \_\_\_\_\_  
 Fixture Material: Metal \_\_\_\_\_

### ELECTRICAL

Lamp Type: LED \_\_\_\_\_  
 Input Wattage (W): 21 \_\_\_\_\_  
 Total Output Wattage (W): 20 \_\_\_\_\_  
 Dimming: Tri-Mode (Non-Dimming and Phase Dimming (120Vac only) and 0-10V Dimming) \_\_\_\_\_  
 Driver Included: Yes \_\_\_\_\_  
 Driver Location: Integrated \_\_\_\_\_  
 Driver Type: Constant Current - Universal \_\_\_\_\_  
 Driver Class: Class 2 \_\_\_\_\_  
 Input Voltage (V): 120 - 277 \_\_\_\_\_  
 Constant Current (MA): 250 \_\_\_\_\_  
 Upon Request: 0-10Vdc dimming / Phase dimming @120Vac / 277Vac \_\_\_\_\_

### LED

Number of LEDs: 2 \_\_\_\_\_  
 Color Temperature (°K): 3000 \_\_\_\_\_  
 Max. Delivered Lumen (lm): 1100 \_\_\_\_\_  
 CRI: >85 CRI \_\_\_\_\_  
 Lamp Life (hrs): 50000 \_\_\_\_\_

### OPTICAL

#### RATINGS AND CERTIFICATIONS

Certified By: Certified for North American Standards \_\_\_\_\_  
 IP rating: IP20 \_\_\_\_\_

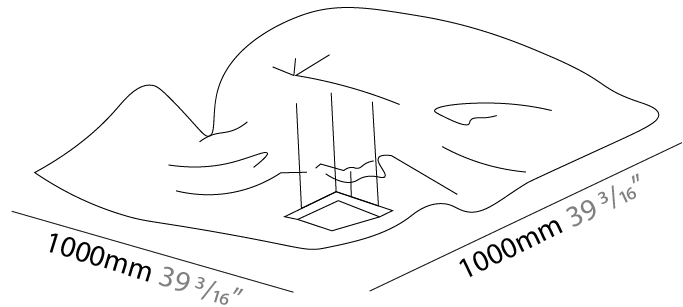

PROJECT
TYPE
SPECIFIER
QUANTITY
DATE

## CRASH SURFACE

**D132109-** \_\_\_\_\_  
base number

- To build a product code in our configurator select the specify button on the base model # product page
- To build a manual product code on this datasheet choose from the options listed below in blue font and add the suffix to the base model #

### GENERAL

Series: Crash  
 Brand: Knikerboker  
 Division: Design  
 Mounting Type: Surface  
 Mounting Location: Ceiling  
 Subcategory: Pendant

### PHYSICAL

Shape: Abstract  
 Length (mm): 200  
 Length (in): 7 7/8  
 Width (mm): 200  
 Width (in): 7 7/8  
 Height (mm): 250  
 Height (in): 9 13/16  
 Light Distribution: Indirect  
 Fixture Finish: EWH / EBK / MAN / COF / PRD / SLF / GLF / CLF / BRL / EWS / EWG / EWC / EWR / EBS / EBG / EBC / EBB / MAS / MAD / MAC / MAB / COS / CGO / CCL / CBL / PRS / PRG / PRC / PRB  
 Fixture Material: Metal

### ELECTRICAL

Lamp Type: LED  
 Input Wattage (W): 10.5  
 Total Output Wattage (W): 10  
 Dimming: Tri-Mode (Non-Dimming and Phase Dimming (120Vac only) and 0-10V Dimming)  
 Driver Included: Yes  
 Driver Location: Integrated  
 Driver Type: Constant Current - Universal  
 Driver Class: Class 2  
 Input Voltage (V): 120 - 277  
 Constant Current (MA): 250  
 Upon Request: 0-10Vdc Dimming / Phase dimming @120Vac only / Non-dimming 120/277Vac

### LED

Number of LEDs: 1  
 Color Temperature (°K): 3000  
 Max. Delivered Lumen (lm): 1100  
 CRI: >85 CRI  
 Lamp Life (hrs): 50000

### OPTICAL

### RATINGS AND CERTIFICATIONS

Certified By: Certified for North American Standards  
 IP rating: IP20

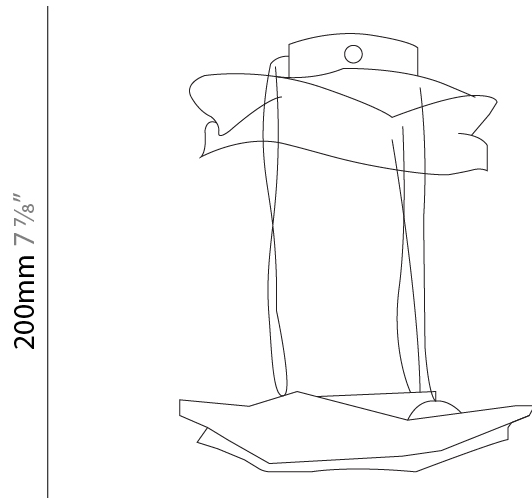

200mm 7 7/8"

200mm 7 7/8"



## CRASH SURFACE

D132109-

PROJECT \_\_\_\_\_

TYPE \_\_\_\_\_

SPECIFIER \_\_\_\_\_

QUANTITY \_\_\_\_\_

DATE \_\_\_\_\_

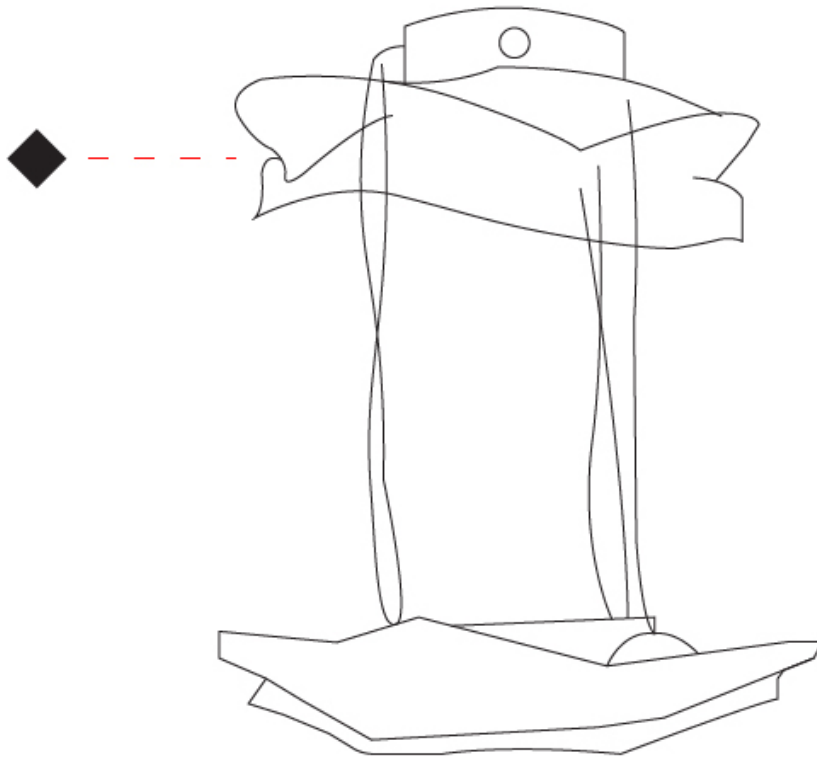

PROJECT	_____
TYPE	_____
SPECIFIER	_____
QUANTITY	_____
DATE	_____

## CRASH SURFACE

### D133000-

base number Finish  
Options

- To build a product code in our configurator select the specify button on the base model # product page
- To build a manual product code on this datasheet choose from the options listed below in blue font and add the suffix to the base model #

#### GENERAL

Series: Crash  
 Brand: Knikerboker  
 Division: Design  
 Mounting Type: Surface  
 Mounting Location: Wall  
 Subcategory: Ambient

#### PHYSICAL

Shape: Square  
 Length (mm): 750  
 Length (in): 29 1/2  
 Width (mm): 750  
 Width (in): 29 1/2  
 Extension (mm): 260  
 Extension (in): 10 1/4  
 Light Distribution: Indirect  
 Fixture Finish: EWH / EBK / MAN / COF / PRD / SLF / GLF / CLF / BRL  
 Fixture Material: Metal

#### ELECTRICAL

Lamp Type: LED  
 Input Wattage (W): 10.5  
 Total Output Wattage (W): 10  
 Dimming: Tri-Mode (Non-Dimming and Phase Dimming (120Vac only) and 0-10V Dimming)  
 Driver Included: Yes  
 Driver Location: Integrated  
 Driver Type: Constant Current - Universal  
 Driver Class: Class 2  
 Input Voltage (V): 120 - 277  
 Constant Current (MA): 250  
 Upon Request: 0-10Vdc dimming / Phase dimming @120Vac only / Non-dimming 120/277Vac

#### LED

Number of LEDs: 1  
 Color Temperature (°K): 3000  
 Max. Delivered Lumen (lm): 1100  
 CRI: >85 CRI  
 Lamp Life (hrs): 50000

#### OPTICAL

#### RATINGS AND CERTIFICATIONS

Certified By: Certified for North American Standards  
 IP rating: IP20

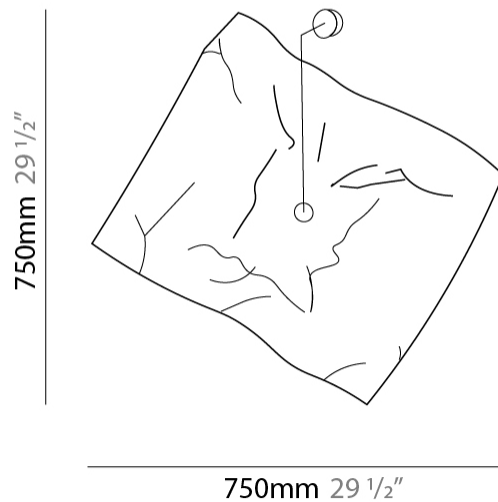

## CRASH SURFACE

### D133003-

base number                      Finish                       
Options                     

1. To build a product code in our configurator select the specify button on the base model # product page
2. To build a manual product code on this datasheet choose from the options listed below in blue font and add the suffix to the base model #

#### GENERAL

Series: Crash                       
Brand: Knikerboker                       
Division: Design                       
Mounting Type: Surface                       
Mounting Location: Wall                       
Subcategory: Ambient                     

#### PHYSICAL

Shape: Rectangle                       
Length (mm): 1000                       
Length (in): 39 <sup>3</sup>/<sub>8</sub>                       
Height (mm): 1000                       
Height (in): 39 <sup>3</sup>/<sub>8</sub>                       
Extension (mm): 260                       
Extension (in): 10 <sup>1</sup>/<sub>4</sub>                       
Light Distribution: Indirect                       
[Fixture Finish: EWH / EBK / MAN / COF / PRD / SLF / GLF / CLF / BRL](#)                       
Fixture Material: Metal                     

#### ELECTRICAL

Lamp Type: LED                       
Input Wattage (W): 10.5                       
Total Output Wattage (W): 10                       
Dimming: Tri-Mode (Non-Dimming and Phase Dimming (120Vac only) and 0-10V Dimming)                       
Driver Included: Yes                       
Driver Location: Integrated                       
Driver Type: Constant Current - Universal                       
Driver Class: Class 2                       
Input Voltage (V): 120 - 277                       
Constant Current (MA): 250                       
Upon Request: 0-10Vdc dimming / Phase dimming @120Vac / 277Vac                     

#### LED

Number of LEDs: 1                       
Color Temperature (°K): 3000                       
Max. Delivered Lumen (lm): 1100                       
CRI: >85 CRI                       
Lamp Life (hrs): 50000                     

#### OPTICAL

#### RATINGS AND CERTIFICATIONS

Certified By: Certified for North American Standards                       
IP rating: IP20                     

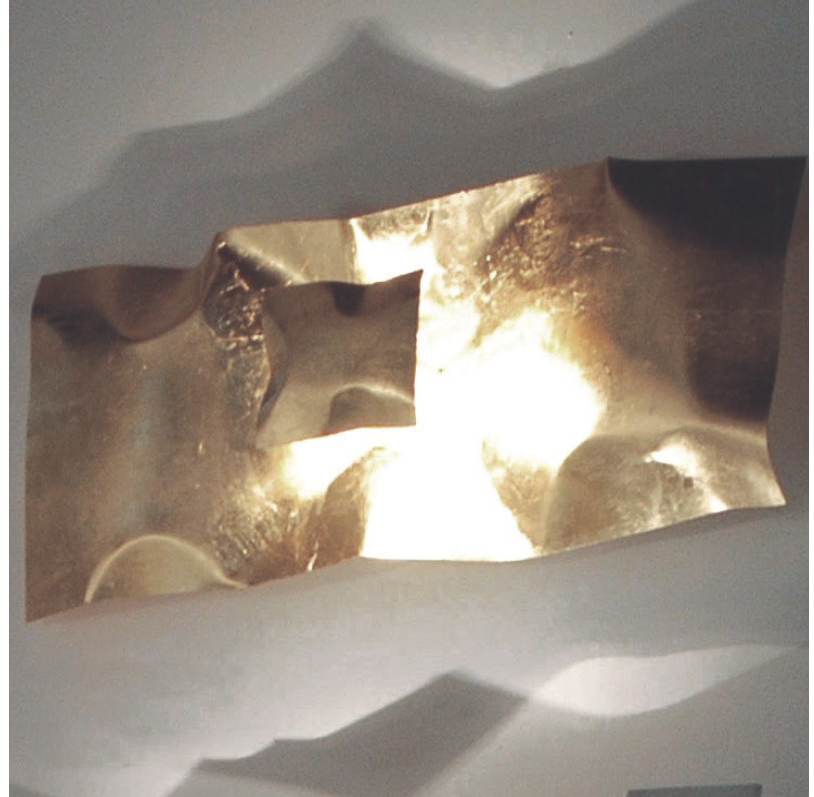

## CRASH

### COLOR FINISH CHART

#### Fixture Finish

Embossed White - EWH



Embossed Black - EBK

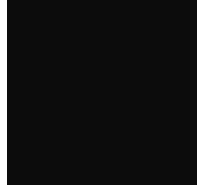

Metallic Anthracite - MAN



Coffee - COF

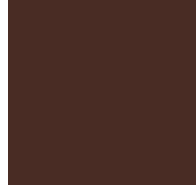

Purple Red - PRD



Silver Leaf - SLF

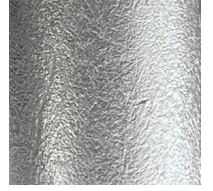

Gold Leaf - GLF



Copper Leaf - CLF

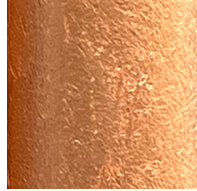

Bronze Leaf - BRL



Metallic Anthracite / Silver Leaf - MAS

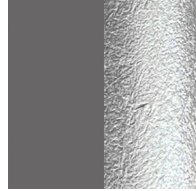

Metallic Anthracite / Gold Leaf - MAD

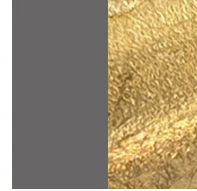

Metallic Anthracite / Copper Leaf - MAC

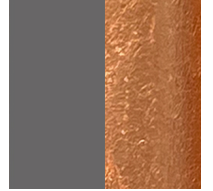

Metallic Anthracite / Bronze Leaf - MAB



Coffee / Silver Leaf - COS

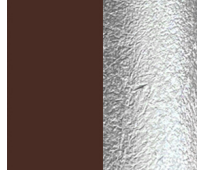

Coffee / Gold Leaf - CGO

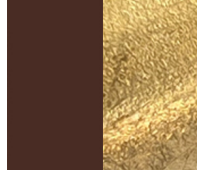

Coffee / Copper Leaf - CCL



Coffee / Bronze Leaf - CBL



Purple Red / Silver Leaf - PRS

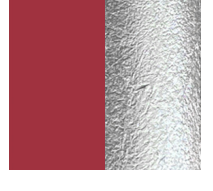

Purple Red / Gold Leaf - PRG



Purple Red / Copper Leaf - PRC

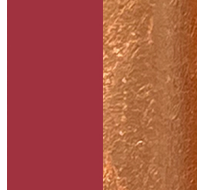

Purple Red / Bronze Leaf - PRB



**Digital:** Not all screens are calibrated the same, and therefore, colors will appear differently between screens.

**Physical:** When texture is involved, there will be variations in color, character and tone within a product series and between product families.



### LEGEND

	floor-mounted		pivotal		special LED (upon request) RGB, RGBW, tunable, gold+, meat+, art+, fashion+
	wall and ceiling: recessed and surface mounted		rotating		warm dim / natural dimming LED
	ceiling-mounted and wall-mounted		illuminate tilted		rechargeable battery powered
	wall-mounted		color of suspension cable		fixture with natural vivid LED (upon request)
	omni-directional light distribution		length of suspension cable		color rendering index
	direct light distribution		reflector degree selection		color temperature
	direct/indirect light distribution		super spot		lumen (luminous flux)
	indirect light distribution		lens		efficacy (lumens per watt)
	asymmetric light distribution		lens pack		Unified Glare Rating (UGR) range from 5-40
	aura light distribution		shine ring		marine grade (AISI 316 stainless steel)
	round wall or ceiling cut-out		integrated shine ring with diffuser		walk on
	square wall or ceiling cut-out		free individual colors 01-29		drive on
	the supplied jig specifies the cutout dimensions		individual colors: 00 (free of charge), 01-25 (extra charge)		Dark Sky Compliance
	minimum distance (meters) lamp - object		luminaire part to be colored (F1)		Americans with Disabilities Act (less than 4" off the wall located between 27"-84" from floor)
	recessed depth		luminaire part to be colored (F2)		lamp protected against explosion
	ceiling thickness in mm		luminaire part to be colored (F3)		blown glass using traditional methods by master glass blower
	ceiling thickness selection		luminaire part to be colored (F4)		acoustic material
	dimmable DP (phase), DV (0-10V), DD (dali), DS (step-dim)		luminaire part to be colored (F5)		protection class I, protection insulation
	included or excluded LED driver/transformer/control gear		color of 3-circuit adaptor		protection class II, protection insulation
	separately switchable		indirect diffuser		ETL Certified to UL and CSA Standards
	sensor		direct diffuser		UL Certified to UL and CSA Standards
	remote control		ball-proof (upon request)		CSA Certified to UL and CSA Standards
	available upon request		accessory		Certified for North American Standards

### IP RATING

	protected against ingress of solid bodies greater than 12.5mm (finger)
	protected against ingress of solid bodies greater than 2.5mm protected against sprays of water up to 60 degrees from the vertical (rain)
	protected against ingress of solid bodies greater than 1mm (wire) no protection against the ingress of moisture
	protected against ingress of solid bodies greater than 1mm (wire) protected against sprays of water up to 60 degrees from the vertical (rain)
	protected against ingress of solid bodies greater than 1mm (wire) protected against water splashed from all directions
	protected against limited ingress of dust (wet rooms/covered outdoor areas) protected against water splashed from all directions
	protected against ingress of dust protected against jets of water
	protected against ingress of dust protected against powerful jets of water or heavy seas
	protected against ingress of dust protected against immersion of water between 15cm - 1m for 30 minutes
	protected against ingress of dust protected against immersion of water under pressure for long periods

### IK RATING

	protected against 0.14 joules impact (equivalent to 0.25kg mass dropped from 56mm above the surface)
	protected against 0.2 joules impact (equivalent to 0.25kg mass dropped from 80mm above the surface)
	protected against 0.35 joules impact (equivalent to 0.25kg mass dropped from 140mm above the surface)
	protected against 0.5 joules impact (equivalent to 0.25kg mass dropped from 200mm above the surface)
	protected against 0.7 joules impact (equivalent to 0.25kg mass dropped from 280mm above the surface)
	protected against 1 joules impact (equivalent to 0.25kg mass dropped from 400mm above the surface)
	protected against 2 joules impact (equivalent to 0.5kg mass dropped from 400mm above the surface)
	protected against 5 joules impact (equivalent to 1.7kg mass dropped from 300mm above the surface)
	protected against 10 joules impact (equivalent to 5.0kg mass dropped from 200mm above the surface)
	protected against 20 joules impact (equivalent to 5.0kg mass dropped from 400mm above the surface)